

Kabelstecker ohne Zugentlastung
Male cable connector without strain relief

Kabelstecker mit Zugentlastung
Male cable connector with strain relief

Kabeldose ohne Zugentlastung
Female cable connector without strain relief

Kabeldose mit Zugentlastung
Female cable connector with strain relief

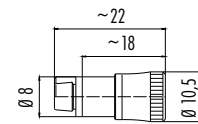
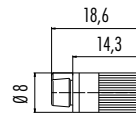
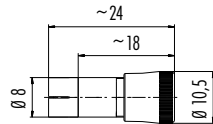
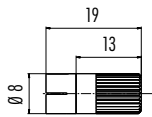

Polzahl Contacts	Kabel-Ø max. Max. cable Ø	Bestell-Nr. Ordering-No.	Polzahl Contacts	Kabel-Ø max. Max. cable Ø	Bestell-Nr. Ordering-No.	Polzahl Contacts	Kabel-Ø max. Max. cable Ø	Bestell-Nr. Ordering-No.	Polzahl Contacts	Kabel-Ø max. Max. cable Ø	Bestell-Nr. Ordering-No.
3	3,6 mm	09 9747 00 03	3	3–4 mm	09 9747 70 03	3	3,6 mm	09 9748 00 03	3	3–4 mm	09 9748 70 03
				4–5 mm	09 9747 71 03					4–5 mm	09 9748 71 03
4	3,6 mm	09 9767 00 04	4	3–4 mm	09 9767 70 04	4	3,6 mm	09 9764 00 04	4	3–4 mm	09 9764 70 04
				4–5 mm	09 9767 71 04					4–5 mm	09 9764 71 04
5	3,6 mm	09 9789 00 05	5	4–5 mm	09 9789 71 05	5	3,6 mm	09 9790 00 05	5	4–5 mm	09 9790 71 05

Polzahl	3	4	5	Number of contacts
Steckverbinder Verriegelung	schnapp/snap-in			Connector locking system
Anschlussart	löten/solder			Termination
Anschlussquerschnitt	max. 0,25 mm ² (max. AWG 24)			Wire gauge
Kabeldurchlass	3–5 mm			Cable outlet
Schutzart	IP40			Degree of protection
Mechanische Lebensdauer	> 100 Steckzyklen/> 100 mating cycles			Mechanical operation
Obere Grenztemperatur	+ 70 °C			Upper temperature
Untere Grenztemperatur	– 25 °C			Lower temperature
Bemessungsspannung	60 V			Rated voltage
Bemessungs-Stoßspannung	800 V			Rated impulse voltage
Verschmutzungsgrad	1			Pollution degree
Überspannungskategorie	II			Overvoltage categorie
Isolierstoffgruppe	III			Material group
Bemessungsstrom (40°C)	3 A			Rated current (40 °C)
Material Kontakt	Stift/pin CuZn (Messing/brass), Buchse/socket CuSn (Bronze/bronze)			Material of contact
Kontaktoberfläche	Au (Gold/gold)			Contact plating
Material Kontaktkörper	PA			Material of contact body
Material Gehäuse	PA			Material of housing
Material Verriegelung	—			Material of locking

Flanschstecker Lötanschluss
Male panel mount connector,
solder termination

Flanschstecker Tauchlötanschluss
Male panel mount connector,
dip solder termination

Flanschdose Lötanschluss
Female panel mount connector,
solder termination

Flanschdose Tauchlötanschluss
Female panel mount connector,
dip solder termination

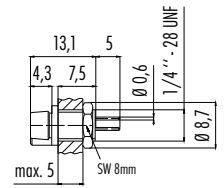
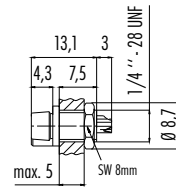
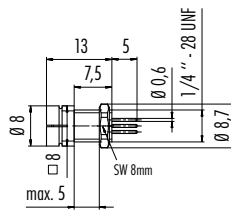
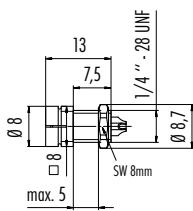

Polzahl Contacts	Bestell-Nr. Ordering-No.	Polzahl Contacts	Bestell-Nr. Ordering-No.	Polzahl Contacts	Bestell-Nr. Ordering-No.	Polzahl Contacts	Bestell-Nr. Ordering-No.
3	09 9749 30 03	3	09 9749 20 03	3	09 9750 30 03	3	09 9750 20 03
4	09 9765 30 04	4	09 9765 20 04	4	09 9766 30 04	4	09 9766 20 04
5	09 9791 30 05	5	09 9791 20 05	5	09 9792 30 05	5	09 9792 20 05

Polzahl	3	4	5	Number of contacts
Steckverbinder Verriegelung	schnapp/snap-in			Connector locking system
Anschlussart	löten, tauchlöten/solder, dip solder			Termination
Anschlussquerschnitt	max. 0,25 mm ² (max. AWG 24)			Wire gauge
Kabeldurchlass	—			Cable outlet
Schutzart	IP40			Degree of protection
Mechanische Lebensdauer	> 100 Steckzyklen/> 100 mating cycles			Mechanical operation
Obere Grenztemperatur	+ 70 °C			Upper temperature
Untere Grenztemperatur	- 25 °C			Lower temperature
Bemessungsspannung	60 V			Rated voltage
Bemessungs-Stoßspannung	800 V			Rated impulse voltage
Verschmutzungsgrad	1			Pollution degree
Überspannungskategorie	II			Overvoltage categorie
Isolierstoffgruppe	III			Material group
Bemessungsstrom (40°C)	3 A			Rated current (40 °C)
Material Kontakt	Stift/pin CuZn (Messing/brass), Buchse/socket CuSn (Bronze/bronze)			Material of contact
Kontaktoberfläche	Au (Gold/gold)			Contact plating
Material Kontaktkörper	PA			Material of contact body
Material Gehäuse	PA			Material of housing
Material Verriegelung	—			Material of locking

Kabelstecker umspritzt
Male cable connector moulded



Kabeldose umspritzt
Female cable connector moulded

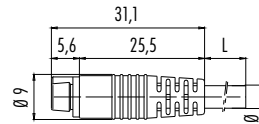
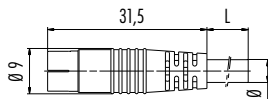

Polzahl Contacts	Kabellänge 2 m Cable length 2 m	Kabellänge 5 m Cable length 5 m	Polzahl Contacts	Kabellänge 2 m Cable length 2 m	Kabellänge 5 m Cable length 5 m
3	79 9001 12 03	79 9001 15 03	3	79 9002 12 03	79 9002 15 03
4	79 9003 12 04	79 9003 15 04	4	79 9004 12 04	79 9004 15 04
5	—	79 9005 15 05	5	79 9006 12 05	79 9006 15 05

Technische Daten Kabel	3	4	5	Specifications of cable
Querschnitt mm ² ¹⁾	3 x 0,25 mm ² (AWG 24)	4 x 0,25 mm ² (AWG 24)	5 x 0,25 mm ² (AWG 24)	Wire gauge mm ² ¹⁾
Material Mantel	PVC			Material jacket
Isolation Litze	PVC			Insulation wire
Litzenaufbau (mm)	32 x 0,1		14 x 0,15	Design of wire (mm)
Kabelmantel Ø (mm)	4,5 ±0,2	4,5 ±0,2	5 ±0,2	Cable jacket Ø (mm)
Leiterwiderstand	80 Ω/Km (20 °C)			Resistance of wire
Temp.-Bereich (Kabel bew.)	- 5 °C /+ 70 °C			Temp. range (cable in move)
Temp.-Bereich (Kabel fest)	- 25 °C /+ 70 °C			Temp. range (cable fixed)
Biegeradius (Kabel bew.)	45 mm		50 mm	Bending radius (cable in move)
Biegeradius (Kabel fest)	22 mm		25 mm	Bending radius (cable fixed)
Zulassung	—			Approval

Polzahl	3	4	5	Number of contacts
Steckverbinder Verriegelung	schnapp/snap-in			Connector locking system
Anschlussart	am Kabel angespritzt/moulded			Termination
Anschlussquerschnitt	0,25 mm ² (AWG 24)			Wire gauge
Kabeldurchlass	—			Cable outlet
Schutzart	IP40			Degree of protection
Mechanische Lebensdauer	> 100 Steckzyklen/> 100 mating cycles			Mechanical operation
Obere Grenztemperatur	+ 70 °C			Upper temperature
Untere Grenztemperatur	- 25 °C			Lower temperature
Bemessungsspannung	60 V			Rated voltage
Bemessungs-Stoßspannung	800 V			Rated impulse voltage
Verschmutzungsgrad	1			Pollution degree
Überspannungskategorie	II			Overvoltage categorie
Isolierstoffgruppe	III			Material group
Bemessungsstrom (40°C)	3 A			Rated current (40 °C)
Material Kontakt	Stift/pin CuZn (Messing/brass), Buchse/socket CuSn (Bronze/bronze)			Material of contact
Kontaktoberfläche	Au (Gold/gold)			Contact plating
Material Kontaktkörper	PA			Material of contact body
Material Gehäuse	PUR			Material of housing
Material Verriegelung	—			Material of locking

¹⁾ Vergleichbare AWG Leiter siehe technische Informationen./ ¹⁾ Comparable AWG conductors see technical information.

Montageanleitung
Assembly instruction

Kabelsteckverbinder ohne Zugentlastung
Cable connector without strain relief

1. Kupplungshülse auf Kabel auffädeln.
2. Kabel abmanteln auf L = 9 mm.
3. Litzen absolieren und anlöten.
4. Kupplungshülse aufschrauben.

1. Bead sleeve to cable.
2. Dismantle cable to 9 mm length.
3. Strip and solder single wires.
4. Screw on sleeve.

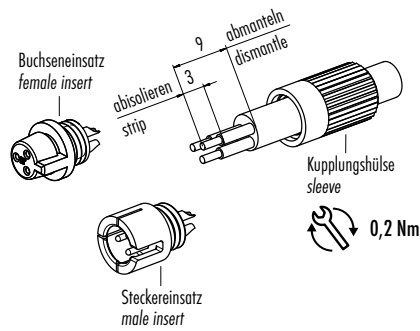

Kabelsteckverbinder mit Zugentlastung
Cable connector with strain relief

1. Druckschraube und Klemmhülse auf Kabel auffädeln.
2. Kabel abmanteln auf L = 9 mm.
3. Litzen absolieren und anlöten.
4. Klemmhülse aufschrauben.
5. Druckschraube festziehen.

1. Bead pressing screw and clamping sleeve to cable.
2. Dismantle cable to 9 mm length.
3. Strip and solder single wires.
4. Screw on clamping sleeve.
5. Tighten pressing screw.

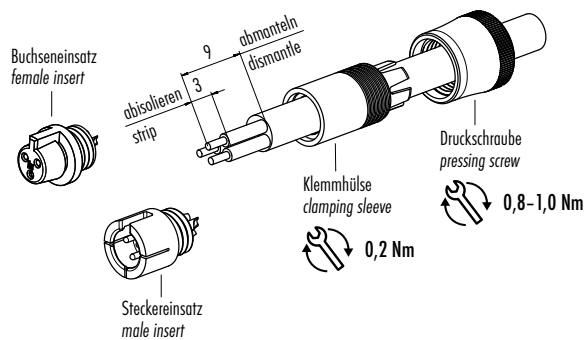

Einzelteildarstellung
Component part drawing

Flanschstecker, löten
Male panel mount connector, solder

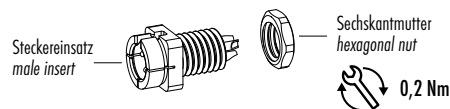

Flanschdose, löten
Female panel mount connector, solder

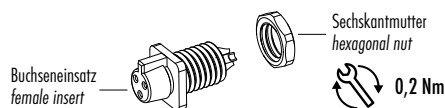

Flanschsteckverbinder, tauchlöten
Panel mount connectors, dip solder

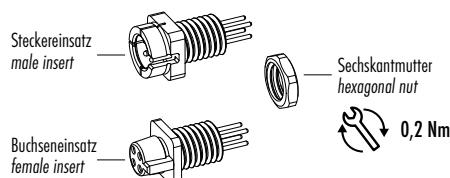

Polbilder
Contact arrangements

Stifteinsatz (Steckseite)
Male insert (mating side)

Buchseinsatz (Steckseite)
Female insert (mating side)

3 pol
3 contacts

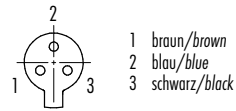
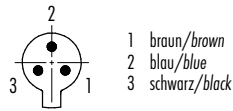

4 pol
4 contacts

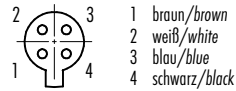
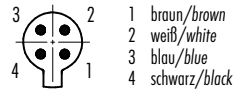

5 pol
5 contacts

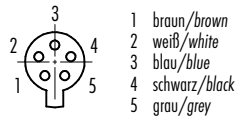
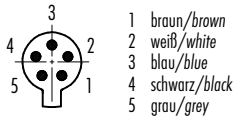

Bohrbilder Stifteinsatz (Leiterplatte)
Drilling schemes male insert (PCB)

Bohrbilder Buchseinsatz (Leiterplatte)
Drilling schemes female insert (PCB)

3 pol
3 contacts

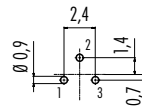
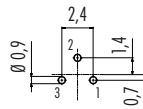

4 pol
4 contacts

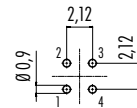
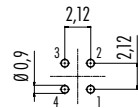

5 pol
5 contacts

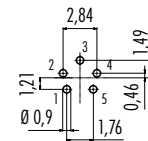
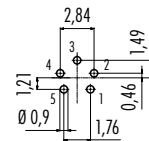

Montageausschnitt
Panel cut out

