

Kabelstecker
Male cable connector

Kabeldose
Female cable connector

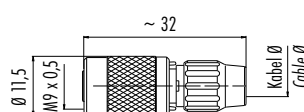
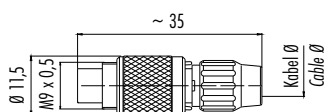

Polzahl Contacts	Kabeldurchlass 3–4 mm Cable outlet 3–4 mm	Kabeldurchlass 4–5 mm Cable outlet 4–5 mm
2	99 0071 100 02	99 0071 102 02
3	99 0075 100 03	99 0075 102 03
4	99 0079 100 04	99 0079 102 04
5	99 0095 100 05	99 0095 102 05
7	99 0475 100 07	99 0475 102 07
8	99 0479 100 08	99 0479 102 08

Polzahl Contacts	Kabeldurchlass 3–4 mm Cable outlet 3–4 mm	Kabeldurchlass 4–5 mm Cable outlet 4–5 mm
2	99 0072 100 02	99 0072 102 02
3	99 0076 100 03	99 0076 102 03
4	99 0080 100 04	99 0080 102 04
5	99 0096 100 05	99 0096 102 05
7	99 0476 100 07	99 0476 102 07
8	99 0480 100 08	99 0480 102 08

Polzahl	2	3	4	5	7	8	Number of contacts
Steckverbinder Verriegelung	schrauben/screw						Connector locking system
Anschlussart	löten/solder						Termination
Anschlussquerschnitt	max. 0,25 mm ² (max. AWG 24)			max. 0,14 mm ² (max. AWG 26)			Wire gauge
Kabeldurchlass	3–4 mm, 4–5 mm						Cable outlet
Schutzart	IP40						Degree of protection
Mechanische Lebensdauer	> 500 Steckzyklen/> 500 mating cycles						Mechanical operation
Obere Grenztemperatur	+ 85 °C						Upper temperature
Untere Grenztemperatur	– 40 °C						Lower temperature
Bemessungsspannung	125 V						Rated voltage
Bemessungs-Stoßspannung	1500 V						Rated impulse voltage
Verschmutzungsgrad	1						Pollution degree
Überspannungskategorie	II						Overvoltage categorie
Isolierstoffgruppe	III						Material group
Bemessungsstrom (40°C)	4 A		3 A		1 A		Rated current (40 °C)
Material Kontakt	Stift/pin CuZn (Messing/brass), Buchse/socket CuSn (Bronze/bronze)						Material of contact
Kontaktoberfläche	Au (Gold/gold)						Contact plating
Material Kontaktkörper	PA/PBT						Material of contact body
Material Gehäuse	PA						Material of housing
Material Verriegelung	CuZn (Messing/brass)						Material of locking

Flanschstecker, löten
Male panel mount connector, solder



Flanschstecker, tauchlöten
Male panel mount connector, dip solder



Flanschstecker mit flexibler Leiterplatte
Male panel mount connector with flexible PCB



Bohrbilder siehe Seite 36
Drilling schemes see page 36

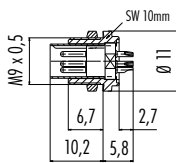

max. Wandstärke: 1,5 mm
max. wall thickness: 1,5 mm

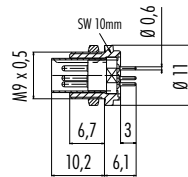

max. Wandstärke: 1,5 mm
max. wall thickness: 1,5 mm

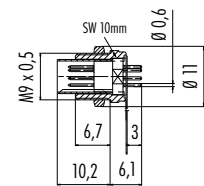

max. Wandstärke: 1,5 mm
max. wall thickness: 1,5 mm

Polzahl Contacts	Bestell-Nr. Ordering-No.	Polzahl Contacts	Bestell-Nr. Ordering-No.	Polzahl Contacts	Bestell-Nr. Ordering-No.
2	09 0073 00 02	2	09 0073 20 02	2	—
3	09 0077 00 03	3	09 0077 20 03	3	—
4	09 0081 00 04	4	09 0081 20 04	4	—
5	09 0097 00 05	5	09 0097 20 05	5	—
7	09 0477 00 07	7	09 0477 22 07	7	09 0477 65 07
8	09 0481 00 08	8	09 0481 22 08	8	09 0481 65 08

Polzahl	2	3	4	5	7	8	Number of contacts
Steckverbinder Verriegelung	schrauben/screw						Connector locking system
Anschlussart	löten/tauchlöten/solder/dip solder						Termination
Anschlussquerschnitt	max. 0,25 mm ² (max. AWG 24)/ —			max. 0,14 mm ² (max. AWG 26)/ —			Wire gauge
Kabeldurchlass	—						Cable outlet
Schutzart	IP40						Degree of protection
Mechanische Lebensdauer	> 500 Steckzyklen/> 500 mating cycles						Mechanical operation
Obere Grenztemperatur	+ 85 °C						Upper temperature
Untere Grenztemperatur	- 40 °C						Lower temperature
Bemessungsspannung	125 V						Rated voltage
Bemessungs-Stoßspannung	1500 V						Rated impulse voltage
Verschmutzungsgrad	1						Pollution degree
Überspannungskategorie	II						Overvoltage categorie
Isolierstoffgruppe	III						Material group
Bemessungsstrom (40°C)	4 A		3 A		1 A		Rated current (40 °C)
Material Kontakt	CuZn (Messing/brass)						Material of contact
Kontaktoberfläche	Au (Gold/gold)						Contact plating
Material Kontaktkörper	PBT						Material of contact body
Material Gehäuse	CuZn (Messing vernickelt/brass nickel plated)						Material of housing
Material Verriegelung	—						Material of locking

Flanschdose, löten
Female panel mount connector, solder



Flanschdose, tauchlöten
Female panel mount connector, dip solder



Flanschdose gewinkelt, tauchlöten
Female angled panel mount connector, dip solder



Flanschdose mit flexibler Leiterplatte
Female panel mount connector with flexible PCB

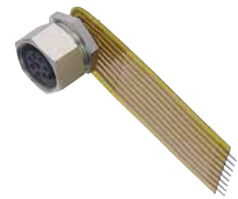

Bohrbilder siehe Seite 36
Drilling schemes see page 36

Bohrbilder siehe Seite 36
Drilling schemes see page 36

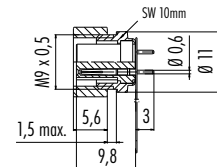
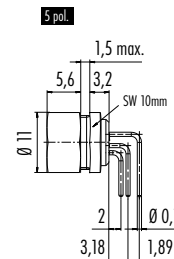
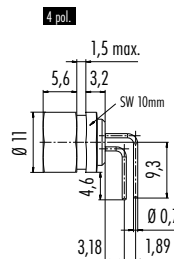
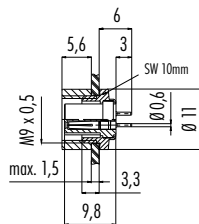
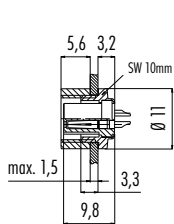

Polzahl Contacts	Bestell-Nr. Ordering-No.	Polzahl Contacts	Bestell-Nr. Ordering-No.	Polzahl Contacts	Bestell-Nr. Ordering-No.	Polzahl Contacts	Bestell-Nr. Ordering-No.
2	09 0074 00 02	2	09 0074 20 02	2	—	2	—
3	09 0078 00 03	3	09 0078 20 03	3	—	3	—
4	09 0082 00 04	4	09 0082 20 04	4	09 0082 32 04	4	—
5	09 0098 00 05	5	09 0098 20 05	5	09 0098 72 05	5	—
7	09 0478 00 07	7	09 0478 22 07	7	—	7	09 0478 65 07
8	09 0482 00 08	8	09 0482 22 08	8	—	8	09 0482 65 08

Polzahl	2	3	4	5	7	8	Number of contacts
Steckverbinder Verriegelung	schrauben/screw						Connector locking system
Anschlussart	löten/tauchlöten/solder/dip solder						Termination
Anschlussquerschnitt	max. 0,25 mm ² (max. AWG 24)/ —			max. 0,14 mm ² (max. AWG 26)/ —			Wire gauge
Kabeldurchlass	—						Cable outlet
Schutzart	IP40						Degree of protection
Mechanische Lebensdauer	> 500 Steckzyklen/> 500 mating cycles						Mechanical operation
Obere Grenztemperatur	+ 85 °C						Upper temperature
Untere Grenztemperatur	- 40 °C						Lower temperature
Bemessungsspannung	125 V						Rated voltage
Bemessungs-Stoßspannung	1500 V						Rated impulse voltage
Verschmutzungsgrad	1						Pollution degree
Überspannungskategorie	II						Overvoltage categorie
Isolierstoffgruppe	III						Material group
Bemessungsstrom (40°C)	4 A		3 A		1 A		Rated current (40 °C)
Material Kontakt	CuSn (Bronze/bronze)						Material of contact
Kontaktoberfläche	Au (Gold/gold)						Contact plating
Material Kontaktkörper	PA						Material of contact body
Material Gehäuse	CuZn (Messing vernickelt/brass nickel plated)						Material of housing
Material Verriegelung	—						Material of locking

Montageanleitung
Assembly instruction

Kabelstecker
Male cable connector

1. Druckschraube auf Kabel auffädeln.
2. Kabel abmanteln auf L = 15 mm.
3. Litzen abisolieren und anlöten.
4. Steckereinsatz in Hülse mit Abstand t montieren.
5. Hülse mit Steckereinsatz in Trägerhalbschale Unterteil setzen.
6. Trägerhalbschale Oberteil auf Unterteil montieren.
7. Gewinding überschnappen.
8. Druckschraube festziehen.

1. Bead pressing screw to cable.
2. Dismantle cable to 15 mm length.
3. Strip and solder single wires.
3. Mount male insert into sleeve with distance t.
4. Insert sleeve with male insert into carrier sleeve part 2 (lower part grey).
5. Mount carrier sleeve part 1 (upper part black) on carrier sleeve part 2 (lower part grey).
6. Snap over coupling ring.
7. Tighten pressing screw.

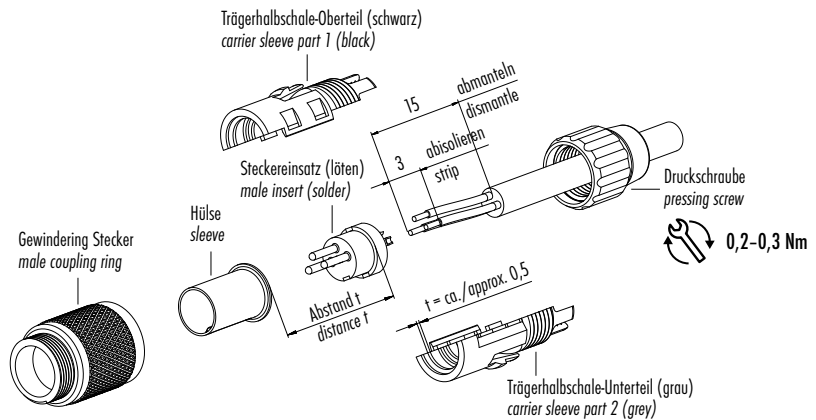

Achtung: max. Drehmoment des Gewindinges im Flanschsteckverbinder: 50cNm (handfest)
Attention: max. torque of ring nut in socket connector: 50cNm (manual adjustment)

Kabeldose
Female cable connector

1. Druckschraube auf Kabel auffädeln.
2. Kabel abmanteln auf L = 15 mm
3. Litzen abisolieren und anlöten.
4. Buchseneinsatz in Trägerhalbschale Unterteil legen.
5. Trägerhalbschale Oberteil auf Unterteil montieren.
6. Gewinding überschnappen.
7. Druckschraube festziehen.

1. Bead pressing screw to cable.
2. Dismantle cable to 15 mm length.
3. Strip and solder single wires.
4. Place female insert into carrier sleeve part 2 (lower part grey).
5. Mount carrier sleeve part 1 (upper part black) on carrier sleeve part 2 (lower part grey).
6. Snap over coupling ring.
7. Tighten pressing screw.

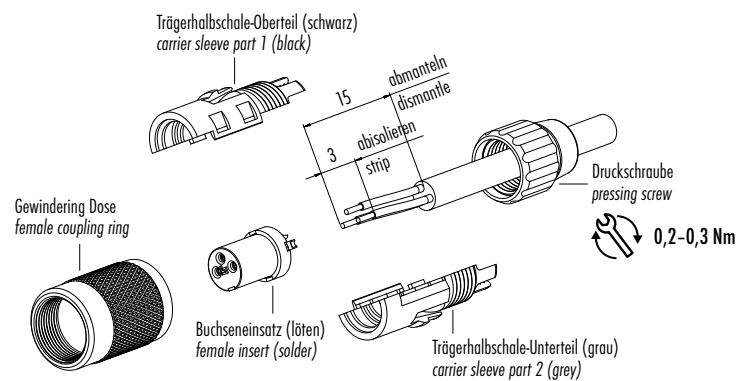

Achtung: max. Drehmoment des Gewindinges im Flanschsteckverbinder: 50cNm (handfest)
Attention: max. torque of ring nut in socket connector: 50cNm (manual adjustment)

Einzelteildarstellung
Component part drawing

Flanschsteckverbinder
Panel mount connectors

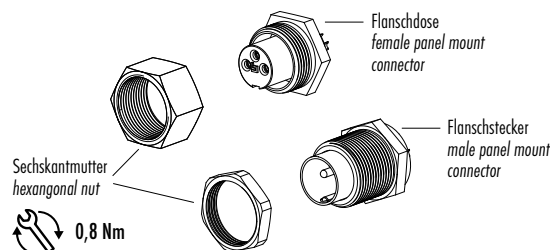

Polbilder
Contact arrangements

Stifteinsatz (Steckseite)
Male insert (mating side)

Buchseinsatz (Steckseite)
Female insert (mating side)

Stifteinsatz (Steckseite)
Male insert (mating side)

Buchseinsatz (Steckseite)
Female insert (mating side)

2 pol
2 contacts

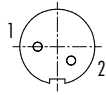
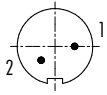

5 pol
5 contacts

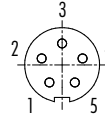
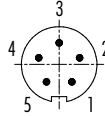

3 pol
3 contacts

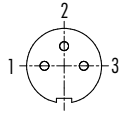
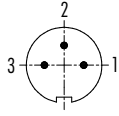

7 pol
7 contacts

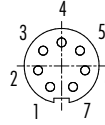
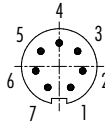

4 pol
4 contacts

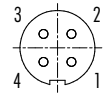
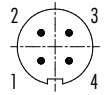

8 pol
8 contacts

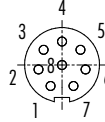
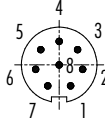

Montageausschnitt
Panel cut out

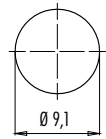

Bohrbilder Stifteinsatz (Leiterplatte)
Drilling schemes male insert (PCB)

Bohrbilder Buchseinsatz (Leiterplatte)
Drilling schemes female insert (PCB)

2 pol
2 contacts

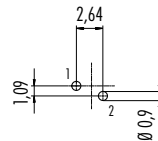
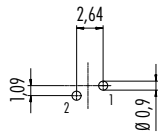

3 pol
3 contacts

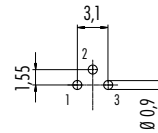
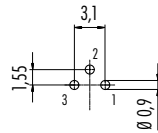

4 pol
4 contacts

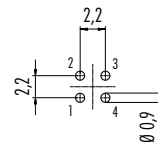
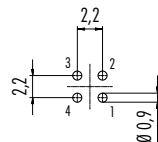

Winkelversion
Angled version

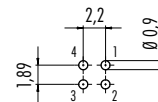

5 pol
5 contacts

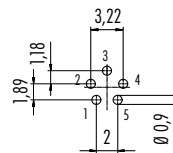
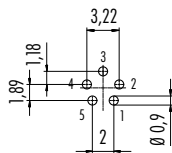

Winkelversion
Angled version

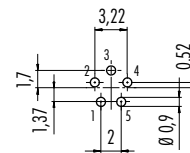

7 pol
7 contacts

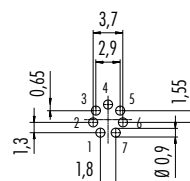
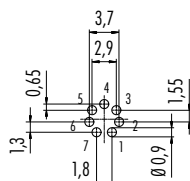

8 pol
8 contacts

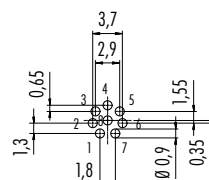
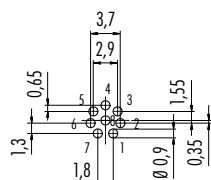

Zeichnungen
Drawings

09 0082 32 04

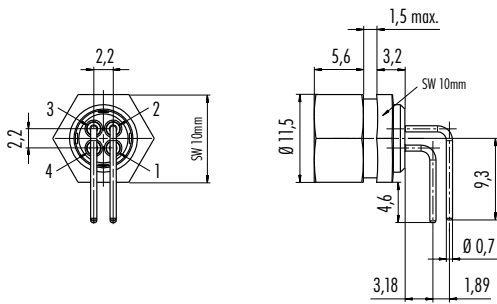

09 0098 72 05

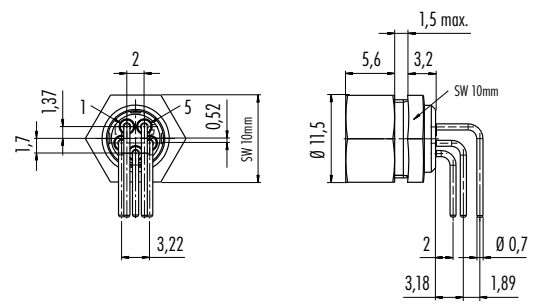

09 0477 65 07

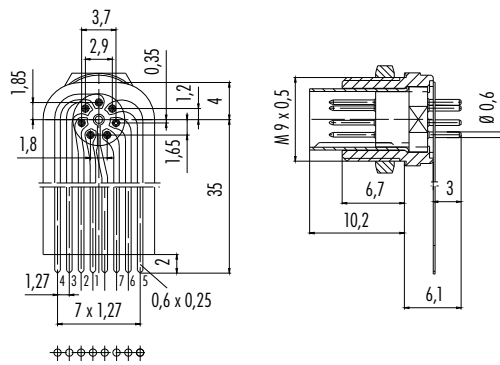

09 0481 65 08

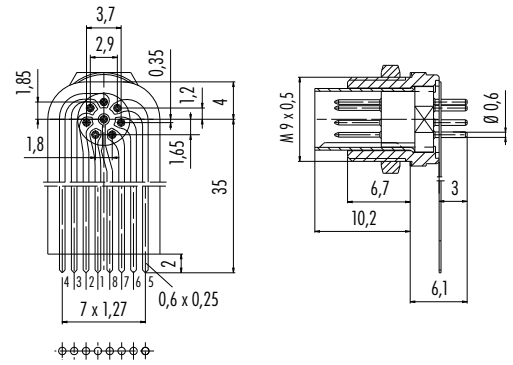

09 0478 65 07

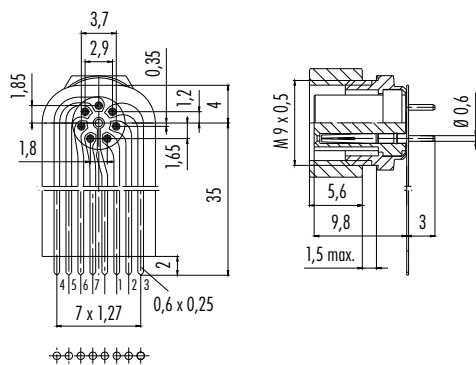

09 0482 65 08

