

RAL 9002

Series	620, 720, 770
Contacts	3, 4, 5, 8, 12
Rated current	7–1 A
Rated voltage	250–60 V
Degree of protection	IP67



RAL 9002 Grey/White Connectors

- Connectors in bright grey/white (similar to RAL 9002) to make pollution visible
- Made of robust Polyamide 66 material providing high size accuracy and rigidity
- Fields of application are medical care and the industrial use of devices needing a bright coloured connector
- High persistence against acetate and alcohol-based disinfectants

Description

620

Male cable connector



Drawing

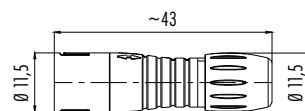

Contacts Cable-Ø Greywhite

Contacts	Cable-Ø	Greywhite
3	3–5 mm	99 9205 400 03
4		99 9209 400 04
5		99 9213 400 05
8		99 9225 400 08

Male cable connector, red, blue, green



Red Blue Green

Contacts	Cable-Ø	Red	Blue	Green
3	3–5 mm	99 9205 450 03	99 9205 460 03	99 9205 470 03
4		99 9209 450 04	99 9209 460 04	99 9209 470 04
5		99 9213 450 05	99 9213 460 05	99 9213 470 05
8		99 9225 450 08	99 9225 460 08	99 9225 470 08

Description

Drawing

Contacts Cable-Ø Greywhite

Female cable connector

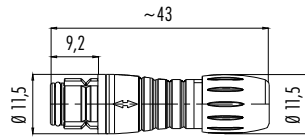

3	3-5 mm	99 9206 400 03
4		99 9210 400 04
5		99 9214 400 05
8		99 9226 400 08

Female cable connector, red, blue, green



	Red	Blue	Green
3	99 9206 450 03	99 9206 460 03	99 9206 470 03
4	99 9210 450 04	99 9210 460 04	99 9210 470 04
5	99 9214 450 05	99 9214 460 05	99 9214 470 05
8	99 9226 450 08	99 9226 460 08	99 9226 470 08

Male panel mount connector, solder termination/dip-solder termination

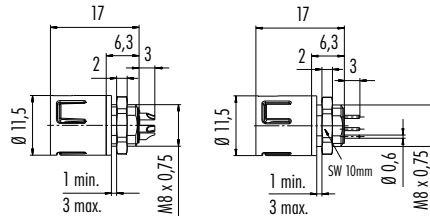

	Solder termination	Dip-solder termination
3	99 9207 400 03	99 9207 490 03
4	99 9211 400 04	99 9211 490 04
5	99 9215 400 05	99 9215 490 05
8	99 9227 400 08	99 9227 490 08

Male panel mount connector, solder termination



	Red	Blue	Green
3	99 9207 050 03	99 9207 060 03	99 9207 070 03
4	99 9211 050 04	99 9211 060 04	99 9211 070 04
5	99 9215 050 05	99 9215 060 05	99 9215 070 05
8	99 9227 050 08	99 9227 060 08	99 9227 070 08

Female panel mount connector, solder termination/dip-solder termination

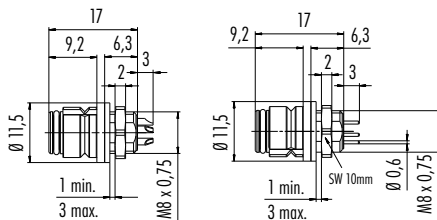

	Solder termination	Dip-solder termination
3	99 9208 400 03	99 9208 490 03
4	99 9212 400 04	99 9212 490 04
5	99 9216 400 05	99 9216 490 05
8	99 9228 400 08	99 9228 490 08

Female panel mount connector, solder termination



	Red	Blue	Green
3	99 9208 050 03	99 9208 060 03	99 9208 070 03
4	99 9212 050 04	99 9212 060 04	99 9212 070 04
5	99 9216 050 05	99 9216 060 05	99 9216 070 05
8	99 9228 050 08	99 9228 060 08	99 9228 070 08

Description

720

Male cable connector



Drawing

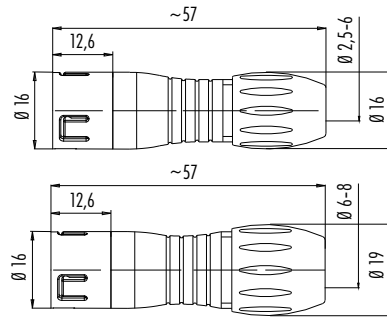

Contacts Cable-Ø Greywhite

Contacts	Cable-Ø	Greywhite
3		99 9105 400 03
5	4-6 mm	99 9113 400 05
8		99 9125 400 08
12	6-8 mm	99 9133 402 12

Male cable connector, red, blue, green



Red Blue Green

Contacts	Cable-Ø	Red	Blue	Green
3		99 9105 450 03	99 9105 460 03	99 9105 470 03
5	4-6 mm	99 9113 450 05	99 9113 460 05	99 9113 470 05
8		99 9125 450 08	99 9125 460 08	99 9125 470 08
12	6-8 mm	99 9133 452 12	99 9133 462 12	99 9133 472 12

Female cable connector

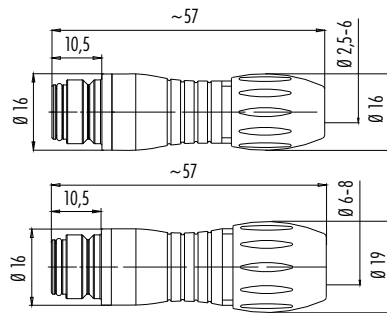

Contacts Cable-Ø Greywhite

Contacts	Cable-Ø	Greywhite
3		99 9106 400 03
5	4-6 mm	99 9114 400 05
8		99 9126 400 08
12	6-8 mm	99 9134 402 12

Female cable connector, red, blue, green



Red Blue Green

Contacts	Cable-Ø	Red	Blue	Green
3		99 9106 450 03	99 9106 460 03	99 9106 470 03
5	4-6 mm	99 9114 450 05	99 9114 460 05	99 9114 470 05
8		99 9126 450 08	99 9126 460 08	99 9126 470 08
12	6-8 mm	99 9134 452 12	99 9134 462 12	99 9134 472 12

Male panel mount connector, solder termination/dip-solder termination

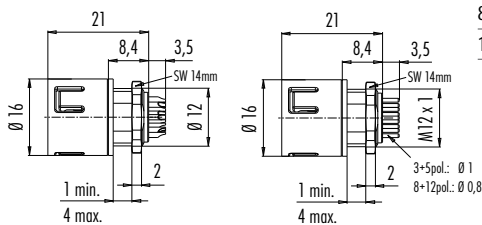

Solder termination Dip-solder termination

Contacts	Solder termination	Dip-solder termination
3	99 9107 400 03	99 9107 490 03
5	99 9115 400 05	99 9115 490 05
8	99 9127 400 08	99 9127 490 08
12	99 9135 400 12	99 9135 490 12

Male panel mount connector, solder termination



Red Blue Green

Contacts	Red	Blue	Green
3	99 9107 50 03	99 9107 60 03	99 9107 70 03
5	99 9115 50 05	99 9115 60 05	99 9115 70 05
8	99 9127 50 08	99 9127 60 08	99 9127 70 08
12	99 9135 50 12	99 9135 60 12	99 9135 70 12

Description

Drawing

Contacts

Solder termination

Dip-solder termination

Female panel mount connector, solder termination/dip-solder termination

3	99 9108 400 03	99 9108 490 03
5	99 9116 400 05	99 9116 490 05
8	99 9128 400 08	99 9128 490 08
12	99 9136 400 12	99 9136 490 12

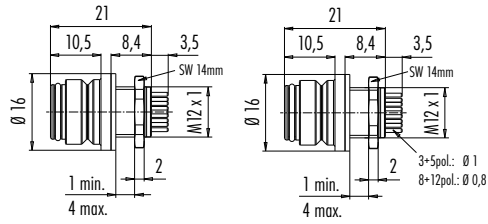

Female panel mount connector, solder termination

	Red	Blue	Green
3	99 9108 50 03	99 9108 60 03	99 9108 70 03
5	99 9116 50 05	99 9116 60 05	99 9116 70 05
8	99 9128 50 08	99 9128 60 08	99 9128 70 08
12	99 9136 50 12	99 9136 60 12	99 9136 70 12



■ **770**

Male cable connector

Contacts

Cable outlet 2,5–4 mm

Cable outlet 4–6 mm

8	99 0771 400 08	99 0771 401 08
---	----------------	----------------

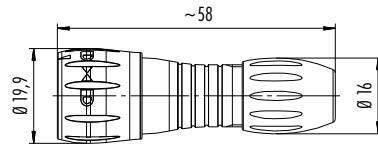

Cable outlet 6–8 mm

8	99 0771 402 08
---	----------------

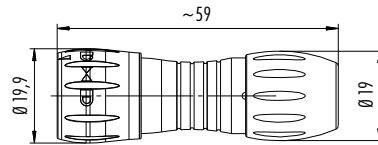

Male cable connector

Bestell-Nr.

8	09 0774 400 08
---	----------------

Female panel mount connector, solder

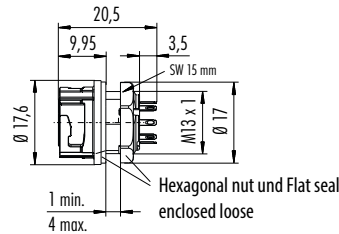

Female panel mount connector, dip-solder

8	09 0774 490 08
---	----------------

