

# Miniatur

Miniature



## Push-Pull Miniatur

### Push-Pull Miniature

#### Kabelsteckverbinder

- Push-Pull-Verriegelung
- 3 – 19-polig
- Schutzart IP40/IP67 <sup>1)</sup>
- Lötanschluss
- Durchmesser 20 mm
- Schirmbar

#### Flanschsteckverbinder

- Push-Pull-Verriegelung
- 3 – 19-polig
- Schutzart IP40/IP67 <sup>1)</sup>
- Lötanschluss
- Durchmesser 25 mm
- Schirmbare Ausführungen

#### Cable Connectors

- Push-pull locking system
- 3 – 19 contacts
- Degree of protection IP40/IP67 <sup>1)</sup>
- Solder termination
- Diameter 20 mm
- Shieldable

#### Panel Mount Connectors

- Push-pull locking system
- 3 – 19 contacts
- Degree of protection IP40/IP67 <sup>1)</sup>
- Solder termination
- Diameter 25 mm
- Shieldable versions

<sup>1)</sup>Erläuterung der Schutzarten siehe technische Informationen./ <sup>1)</sup>Explanation of protection standards see technical information.

**Kabelstecker, schirmbar**  
Male cable connector, shieldable

Abbildung / Figure



**Kabeldose, schirmbar**  
Female cable connector, shieldable



Maßzeichnung / Drawing

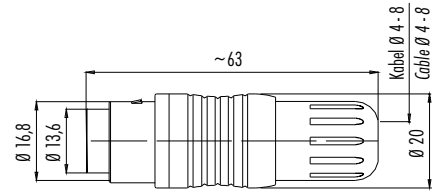
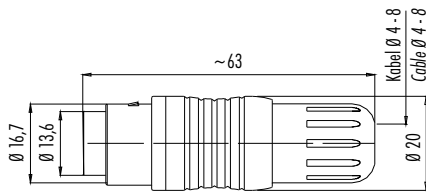

Bestell-Daten / Order Data

Polzahl Contacts	Kabeldurchlass Cable outlet	Bestell-Nr. Ordering-No.
3 DIN	4–8 mm	99 4805 00 03
4	4–8 mm	99 4809 00 04
5	4–8 mm	99 4813 00 05
6 DIN	4–8 mm	99 4817 00 06
7	4–8 mm	99 4825 00 07
8 DIN	4–8 mm	99 4829 00 08
12	4–8 mm	99 4833 00 12
14	4–8 mm	99 4837 00 14
19	4–8 mm	99 4841 00 19

Polzahl Contacts	Kabeldurchlass Cable outlet	Bestell-Nr. Ordering-No.
3 DIN	4–8 mm	99 4806 00 03
4	4–8 mm	99 4810 00 04
5	4–8 mm	99 4814 00 05
6 DIN	4–8 mm	99 4818 00 06
7	4–8 mm	99 4826 00 07
8 DIN	4–8 mm	99 4830 00 08
12	4–8 mm	99 4834 00 12
14	4–8 mm	99 4838 00 14
19	4–8 mm	99 4842 00 19

Technische Daten / Specifications

Polzahl	3 DIN	4	5	6 DIN	7	8 DIN	12	14	19	Number of contacts
Steckverbinder Verriegelung	Push-Pull/Push-Pull									Connector locking system
Anschlussart	löten/solder									Termination
Anschlussquerschnitt	max. 0,75 mm <sup>2</sup> (max. AWG 18)					max. 0,25 mm <sup>2</sup> (max. AWG 24)				Wire gauge
Kabeldurchlass	4–8 mm									Cable outlet
Schutzart	IP67									Degree of protection
Mechanische Lebensdauer	> 1000 Steckzyklen/> 1000 mating cycles									Mechanical operation
Obere Grenztemperatur	+ 85 °C									Upper temperature
Untere Grenztemperatur	– 25 °C									Lower temperature
Bemessungsspannung	150 V (250 V)			32 V (125 V)			32 V (60 V)			Rated voltage
Bemessungs-Stoßspannung	1500 V			500 V (800 V)			500 V			Rated impulse voltage
Verschmutzungsgrad	2 (I) <sup>1)</sup>									Pollution degree
Überspannungskategorie	II (I) <sup>1)</sup>									Overvoltage categorie
Isolierstoffgruppe	III									Material group
Bemessungsstrom (40 °C)	7 A	6 A		5 A				3 A		Rated current (40 °C)
Durchgangswiderstand	≤ 3 mΩ									Contact resistance
Material Kontakt	Stift/pin CuZn (Messing/brass), Buchse/socket CuSn (Bronze/bronze)									Material of contact
Kontaktoberfläche	Au (Gold/gold)									Contact plating
Material Kontaktkörper	PBT									Material of contact body
Material Gehäuse	PA									Material of housing

**Montageanleitung**  
Assembly instruction

1. Abmanteln auf L = 33mm.  
Ummantelung nicht abstreifen.
2. Druckschraube und Klemmvorrichtung auffädeln. Ummantelung auffädeln. Ummantelung entfernen.
3. Litzen abisolieren und verzinnen.
4. Abschirmung auffächern und auskämmen. Die Abschirmlitzen in der Krone rundum einfädeln.
5. Abstandshülse und Klemmvorrichtung verrasten.
6. Gesteckte Einheit nach hinten übers Kabel schieben (ca. 10mm).
7. Einsätze anlöten.
8. Gesteckte Einheit nach vorne schieben bis sie in den Kontakteinsatz einrastet.
9. Abschirmlitzen in Richtung Abschirmung abstreifen und kürzen.  
zu lang: Litzen auf Dichtring - undicht  
zu kurz: kein Kontakt zu Wellenring
10. Montierte Einheit in Trägerhülse stecken und Druckschraube festziehen.

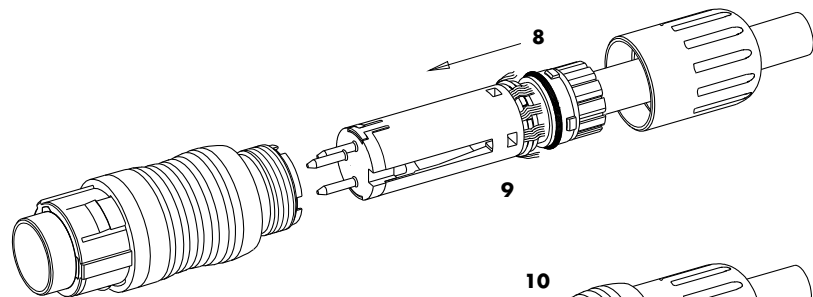
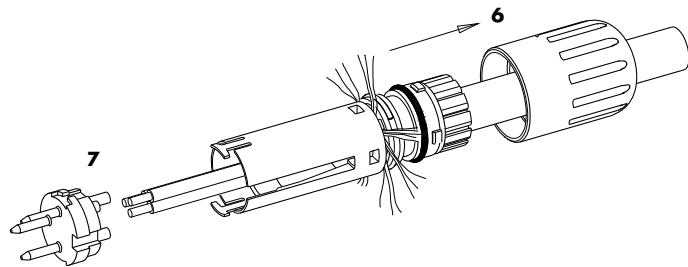
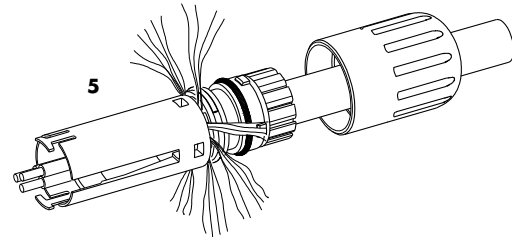
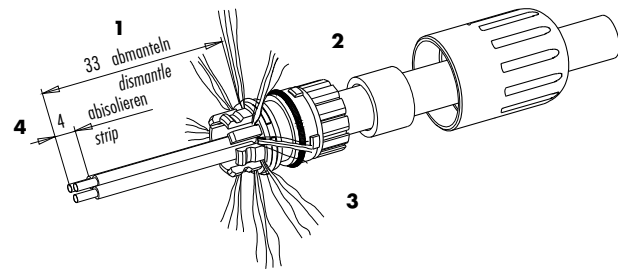

1. Strip to 33mm length but do not take off cable jacket.
2. Bead pressing screw and clamp device. Remove cable jacket.
3. Strip the insulation off the wires and tin them.
4. Fan shielding braid and comb out. Thread wires around top.
5. Lock distance sleeve and clamp device.
6. Push mated units backwards over cable (appr. 10mm).
7. Solder inserts.
8. Push mated units forward until snap-in to contact insert.
9. Strip wires towards shielding ring and shorten.  
too long: wires on sealing ring - not tight  
too short: no contact to wave washer
10. Push assembled unit into carrier sleeve and tighten pressing screw.

**Einzelteildarstellung**  
Component part drawing

**Kabelsteckverbinder**  
Cable connectors

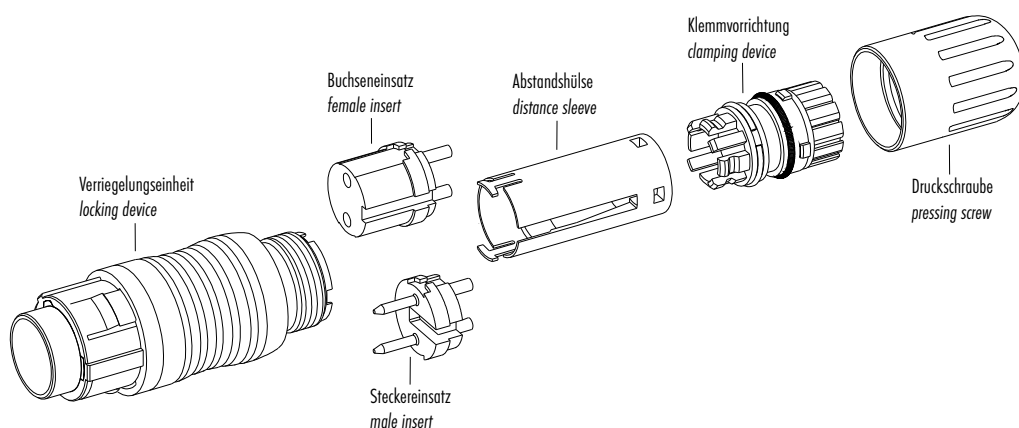

Flanschstecker – IP40 – IP67 – IP67 geschirmt  
Male panel mount connector – IP40 – IP67 – IP67 shielded

Flanschstecker, von vorn verschraubbar – IP67 – IP67 geschirmt  
Male panel mount connector, front fastened – IP67 – IP67 shielded

Abbildung / Figure

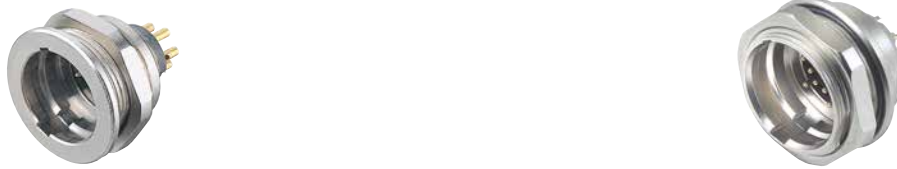

Maßzeichnung / Drawing

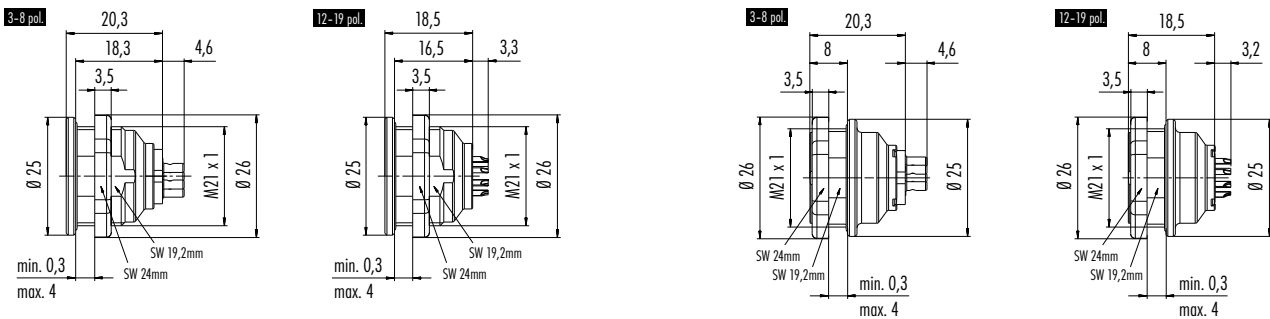

Bestell-Daten / Order Data

Polzahl Contacts	IP40 IP40	IP67 IP67	IP67 geschirmt IP67 shielded
3 DIN	09 4807 25 03	09 4807 15 03	09 4807 00 03
4	09 4811 25 04	09 4811 15 04	09 4811 00 04
5	09 4815 25 05	09 4815 15 05	09 4815 00 05
6 DIN	09 4819 25 06	09 4819 15 06	09 4819 00 06
7	09 4827 25 07	09 4827 15 07	09 4827 00 07
8 DIN	09 4831 25 08	09 4831 15 08	09 4831 00 08
12	09 4835 25 12	09 4835 15 12	09 4835 00 12
14	09 4839 25 14	09 4839 15 14	09 4839 00 14
19	09 4843 25 19	09 4843 15 19	09 4843 00 19

Polzahl Contacts	IP67 IP67	IP67 geschirmt IP67 shielded
3 DIN	09 4807 80 03	09 4807 81 03
4	09 4811 80 04	09 4811 81 04
5	09 4815 80 05	09 4815 81 05
6 DIN	09 4819 80 06	09 4819 81 06
7	09 4827 80 07	09 4827 81 07
8 DIN	09 4831 80 08	09 4831 81 08
12	09 4835 80 12	09 4835 81 12
14	09 4839 80 14	09 4839 81 14
19	09 4843 80 19	09 4843 81 19

Technische Daten / Specifications

Polzahl	3 DIN	4	5	6 DIN	7	8 DIN	12	14	19	Number of contacts
Steckverbinder Verriegelung	Push-Pull/ Push-Pull									Connector locking system
Anschlussart	löten/solder									Termination
Anschlussquerschnitt	max. 0,75 mm <sup>2</sup> (max. AWG 18)				max. 0,25 mm <sup>2</sup> (max. AWG 24)				Wire gauge	
Kabeldurchlass	—									Cable outlet
Schutzart	IP40/IP67									Degree of protection
Mechanische Lebensdauer	> 1000 Steckzyklen/> 1000 mating cycles									Mechanical operation
Obere Grenztemperatur	+ 85 °C									Upper temperature
Untere Grenztemperatur	- 25 °C									Lower temperature
Bemessungsspannung	150 V (250 V)			32 V (125 V)			32 V (60 V)			Rated voltage
Bemessungs-Stoßspannung	1500 V			500 V (800 V)			500 V			Rated impulse voltage
Verschmutzungsgrad	2 (I) <sup>1)</sup>									Pollution degree
Überspannungskategorie	II (I) <sup>1)</sup>									Overvoltage categorie
Isolierstoffgruppe	III									Material group
Bemessungsstrom (40 °C)	7 A	6 A			5 A			3 A		Rated current (40 °C)
Durchgangswiderstand	≤ 3 mΩ									Contact resistance
Material Kontakt	CuZn (Messing/brass)									Material of contact
Kontaktoberfläche	Au (Gold/gold)									Contact plating
Material Kontaktkörper	PBT									Material of contact body
Material Gehäuse	CuZn (Messing vernickelt/brass nickel plated)									Material of housing

**Flanschdose – IP40 – IP67 – IP67 geschirmt**  
Female panel mount connector – IP40 – IP67 – IP67 shielded

**Flanschdose, von vorn verschraubbar – IP67 – IP67 geschirmt**  
Female panel mount connector, front fastened – IP67 – IP67 shielded

Abbildung / Figure



Maßzeichnung / Drawing

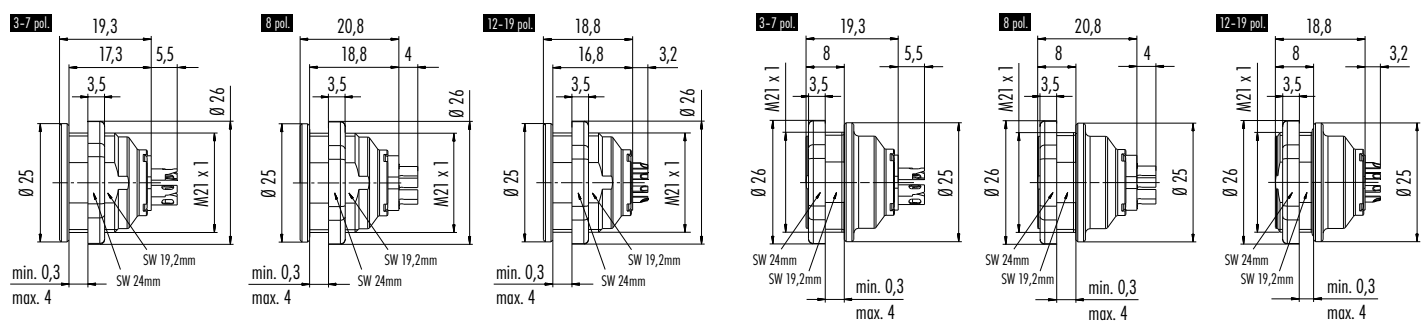

Bestell-Daten / Order Data

Polzahl Contacts	IP40 IP40	IP67 IP67	IP67 geschirmt IP67 shielded
3 DIN	09 4808 25 03	09 4808 15 03	09 4808 00 03
4	09 4812 25 04	09 4812 15 04	09 4812 00 04
5	09 4816 25 05	09 4816 15 05	09 4816 00 05
6 DIN	09 4820 25 06	09 4820 15 06	09 4820 00 06
7	09 4828 25 07	09 4828 15 07	09 4828 00 07
8 DIN	09 4832 25 08	09 4832 15 08	09 4832 00 08
12	09 4836 25 12	09 4836 15 12	09 4836 00 12
14	09 4840 25 14	09 4840 15 14	09 4840 00 14
19	09 4844 25 19	09 4844 15 19	09 4844 00 19

Polzahl Contacts	IP67 IP67	IP67 geschirmt IP67 shielded
3 DIN	09 4808 80 03	09 4808 81 03
4	09 4812 80 04	09 4812 81 04
5	09 4816 80 05	09 4816 81 05
6 DIN	09 4820 80 06	09 4820 81 06
7	09 4828 80 07	09 4828 81 07
8 DIN	09 4832 80 08	09 4832 81 08
12	09 4836 80 12	09 4836 81 12
14	09 4840 80 14	09 4840 81 14
19	09 4844 80 19	09 4844 81 19

Technische Daten / Specifications

Polzahl	3 DIN	4	5	6 DIN	7	8 DIN	12	14	19	Number of contacts
Steckverbinder Verriegelung	Push-Pull/Push-Pull									Connector locking system
Anschlussart	löten/solder									Termination
Anschlussquerschnitt	max. 0,75 mm <sup>2</sup> (max. AWG 18)				max. 0,25 mm <sup>2</sup> (max. AWG 24)					Wire gauge
Kabeldurchlass	—									Cable outlet
Schutzart	IP40/IP67									Degree of protection
Mechanische Lebensdauer	> 1000 Steckzyklen/> 1000 mating cycles									Mechanical operation
Obere Grenztemperatur	+ 85 °C									Upper temperature
Untere Grenztemperatur	- 25 °C									Lower temperature
Bemessungsspannung	150 V (250 V)			32 V (125 V)			32 V (60 V)			Rated voltage
Bemessungs-Stoßspannung	1500 V			500 V (800 V)			500 V			Rated impulse voltage
Verschmutzungsgrad	2 (I) <sup>1)</sup>									Pollution degree
Überspannungskategorie	II (I) <sup>1)</sup>									Overvoltage categorie
Isolierstoffgruppe	III									Material group
Bemessungsstrom (40°C)	7 A	6 A		5 A				3 A		Rated current (40 °C)
Durchgangswiderstand	≤ 3 mΩ									Contact resistance
Material Kontakt	CuSn (Bronze/bronze)									Material of contact
Kontaktoberfläche	Au (Gold/gold)									Contact plating
Material Kontaktkörper	PBT									Material of contact body
Material Gehäuse	CuZn (Messing vernickelt/brass nickel plated)									Material of housing

<sup>1)</sup> Bei Verschm.grad 1, Übersp.kat. I reduzierte Bemessungsspannung./ <sup>1)</sup> In case of pollution degree 1, overvoltage category I rated voltage is reduced.

**Einzelteildarstellung**  
Component part drawing

Flanschsteckverbinder  
Panel mount connectors

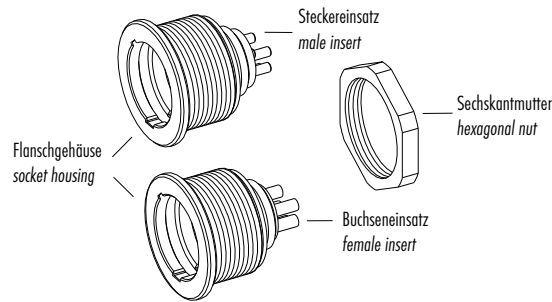

**Polbilder**  
Contact arrangements

**Stifteinsatz (Steckseite)**  
Male insert (mating side)

**Buchseinsatz (Steckseite)**  
Female insert (mating side)

3 pol (DIN 41524)  
3 contacts (DIN 41524)

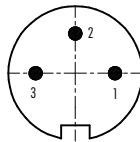

	X	Y
1	3,50	0,00
2	0,00	3,50
3	-3,50	0,00

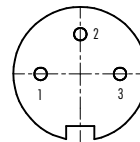

	X	Y
1	-3,50	0,00
2	0,00	3,50
3	3,50	0,00

4 pol  
4 contacts

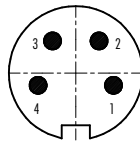

	X	Y
1	3,32	-1,08
2	2,05	2,83
3	-2,05	2,83
4	-3,32	-1,08

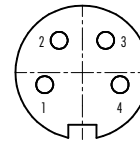

	X	Y
1	-3,32	-1,08
2	-2,05	2,83
3	2,05	2,83
4	3,32	-1,08

5 pol  
5 contacts

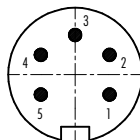

	X	Y
1	3,03	-1,75
2	3,03	1,75
3	0,00	3,50
4	-3,03	1,75
5	-3,03	-1,75

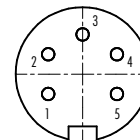

	X	Y
1	-3,03	-1,75
2	-3,03	1,75
3	0,00	3,50
4	3,03	1,75
5	3,03	-1,75

6 pol  
6 contacts

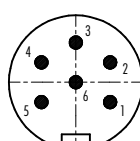

	X	Y
1	3,03	-1,75
2	3,03	1,75
3	0,00	3,50
4	-3,03	1,75
5	-3,03	-1,75
6	0,00	0,00

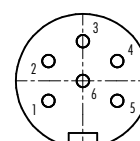

	X	Y
1	-3,03	-1,75
2	-3,03	1,75
3	0,00	3,50
4	3,03	1,75
5	3,03	-1,75
6	0,00	0,00

7 pol  
7 contacts

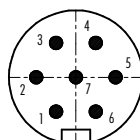

	X	Y
1	-1,75	-3,03
2	-3,50	0,00
3	-1,75	3,03
4	1,75	3,03
5	3,50	0,00
6	1,75	-3,03
7	0,00	0,00

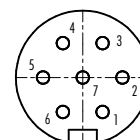

	X	Y
1	1,75	-3,03
2	3,50	0,00
3	1,75	3,03
4	-1,75	3,03
5	-3,50	0,00
6	-1,75	-3,03
7	0,00	0,00

8 pol (DIN 45326)  
8 contacts (DIN 45326)

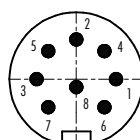

	X	Y
1	3,50	0,00
2	0,00	3,50
3	-3,50	0,00
4	2,47	2,47
5	-2,47	2,47
6	2,47	-2,47
7	-2,47	-2,47
8	0,00	-0,70

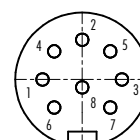

	X	Y
1	-3,50	0,00
2	0,00	3,50
3	3,50	0,00
4	-2,47	2,47
5	2,47	2,47
6	-2,47	-2,47
7	2,47	-2,47
8	0,00	-0,70

**Polbilder**  
Contact arrangements

**Stifteinsatz (Steckseite)**  
Male insert (mating side)

**Buchseinsatz (Steckseite)**  
Female insert (mating side)

12 pol  
12 contacts

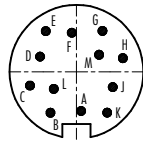

	X	Y
A	0,44	-3,45
B	-2,29	-3,61
C	-4,10	-1,21
D	-3,20	1,34
E	-2,71	3,59
F	-0,41	3,45
G	2,29	3,61
H	4,10	1,21
J	3,20	-1,34
K	2,71	-3,59
L	-2,00	-1,51
M	2,00	1,51

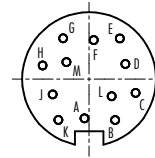

	X	Y
A	-0,44	-3,45
B	2,29	-3,61
C	4,10	-1,21
D	3,20	1,34
E	2,71	3,59
F	0,41	3,45
G	-2,29	3,61
H	-4,10	1,21
J	-3,20	-1,34
K	-2,71	-3,59
L	-2,00	-1,51
M	2,00	1,51

14 pol  
14 contacts

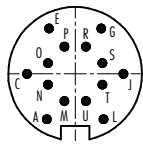

	X	Y
A	-2,50	-4,00
C	-4,25	0,00
E	-2,30	4,00
G	2,30	4,00
J	4,25	0,00
L	2,50	-4,00
M	-0,95	-2,40
N	-2,40	-0,95
O	-2,40	0,95
P	-0,95	2,40
R	0,95	2,40
S	2,40	0,95
T	2,40	-0,95
U	0,95	-2,40

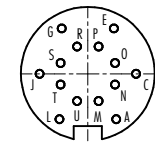

	X	Y
A	2,50	-4,00
C	4,25	0,00
E	2,30	4,00
G	-2,30	4,00
J	-4,25	0,00
L	-2,50	-4,00
M	0,95	-2,40
N	2,40	-0,95
O	2,40	0,95
P	0,95	2,40
R	-0,95	2,40
S	-2,40	0,95
T	-2,40	-0,95
U	-0,95	-2,40

19 pol  
19 contacts

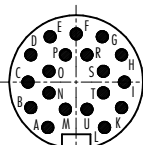

	X	Y
A	-2,50	-4,00
B	-4,00	-2,25
C	-4,25	0,00
D	-4,00	2,40
E	-2,30	4,00
F	0,00	4,25
G	2,30	4,00
H	4,00	2,40
I	4,25	0,00
K	4,00	-2,25
L	2,50	-4,00
M	-0,95	-2,40
N	-2,40	-0,95
O	-2,40	0,95
P	-0,95	2,40
R	0,95	2,40
S	2,40	0,95
T	2,40	-0,95
U	0,95	-2,40

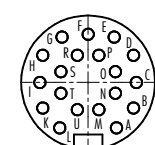

	X	Y
A	2,50	-4,00
B	4,00	-2,25
C	4,25	0,00
D	4,00	2,40
E	2,30	4,00
F	0,00	4,25
G	-2,30	4,00
H	-4,00	2,40
I	-4,25	0,00
K	-4,00	-2,25
L	-2,50	-4,00
M	0,95	-2,40
N	2,40	-0,95
O	2,40	0,95
P	0,95	2,40
R	-0,95	2,40
S	-2,40	0,95
T	-2,40	-0,95
U	-0,95	-2,40

**Montageausschnitt**  
Panel cut out

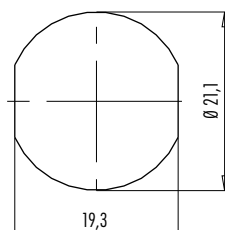



**Schutzkappe für Kabelsteckverbinder, IP67**  
Protection cap for cable connectors, IP67

Abbildung / Figure



Maßzeichnung / Drawing

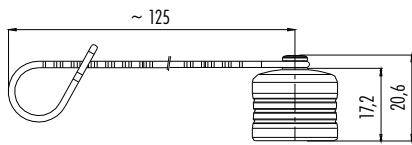

Bestell-Daten / Order Data

Bestell-Nr.  
Ordering-No.

08 2605 000 001

**Schutzkappe für Flanschsteckverbinder, IP67**  
Protection cap for panel mount connectors, IP67

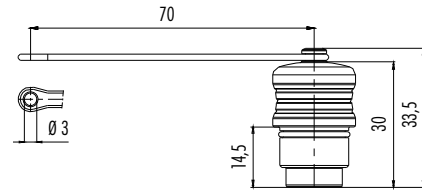

Bestell-Nr.  
Ordering-No.

08 2604 000 001

**Schutzkappe für Flanschsteckverbinder, IP67**  
Protection cap for panel mount connectors, IP67

Abbildung / Figure



Maßzeichnung / Drawing

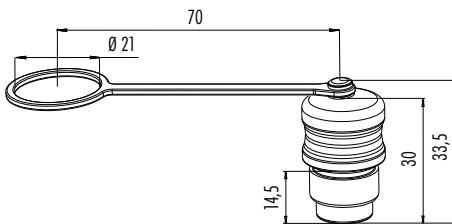

Bestell-Daten / Order Data

Bestell-Nr.  
Ordering-No.

08 2679 000 001

**Schutzkappe für Flanschsteckverbinder, IP40**  
Protection cap for panel mount connectors, IP40

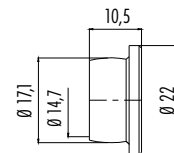

Bestell-Nr.  
Ordering-No.

08 2603 000 000

**Adapter für Kabel-Kabel Verbindung zur Aufnahme eines Flanschsteckverbinders**  
Adapter for a cable-cable connection to mate a panel mount connector

Abbildung / Figure



Maßzeichnung / Drawing

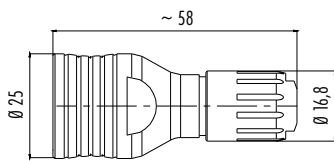

Dichtungen lose beigelegt  
Sealings enclosed

Bestell-Daten / Order Data

Kabeldurchlass Cable outlet	Bestell-Nr. Ordering-No.
4–6 mm 6–8 mm	08 2606 000 001